

GP-X SERIES

New

High Speed·High Accuracy Eddy Current Type Digital Displacement Sensor



High-speed sampling and high resolution
The new proposition for even more variegated data collection and processing.



We've realized a 25 μ s (40,000 times/sec.) ultra high sampling speed

With a 25 μ s ultra high sampling speed, the **GP-X** series won't miss even high speed work displacements.

Now available with ultra-accuracy 0.02 % F.S. resolution measurement

With the resolution, 0.02 % F.S. (Note), they can perform high-accuracy measurements of micro-displacements. (Average number of samples: 64)

Note: **GP-XC3SE** and **GP-XC5SE**
Resolution: 0.04 % F.S.

Stable temperature characteristics, 0.07 % F.S./ $^{\circ}$ C

By combining the sensor head with the controller, we've realized 0.07 % F.S./ $^{\circ}$ C. They are highly resistant to ambient temperature changes enabling stable micro-displacement measurements.

They perform with a ± 0.3 % F.S. linearity for stainless steel and iron

Because they perform with a ± 0.3 % F.S. linearity, they can be used for sensing stainless steel and iron enabling precise measurements not affected by the work's material. Specifications corresponding to each material (stainless steel, iron, aluminum) has already been inputted in the controller enabling the easy selection of the setting that is most suitable for the particular material used.

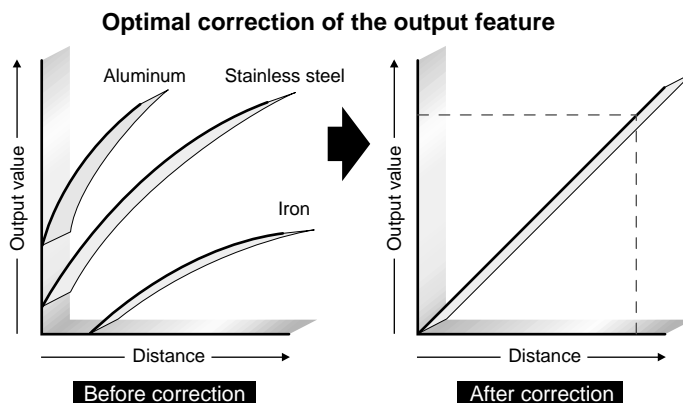

IP67g sensor head variation

6 types of sensor heads from the ultra compact $\phi 3.8$ mm $\phi 0.150$ in cylindrical type to the long range sensing type are available.

All sensor heads are oil-proof as per IP67g (JEM) enabling safe, stable performance even under harsh environments.

The long sensing range of 10 mm 0.394 in type (GP-X22KL) is also available.

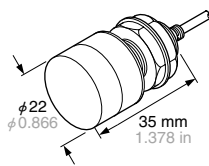

Please contact our office for details.

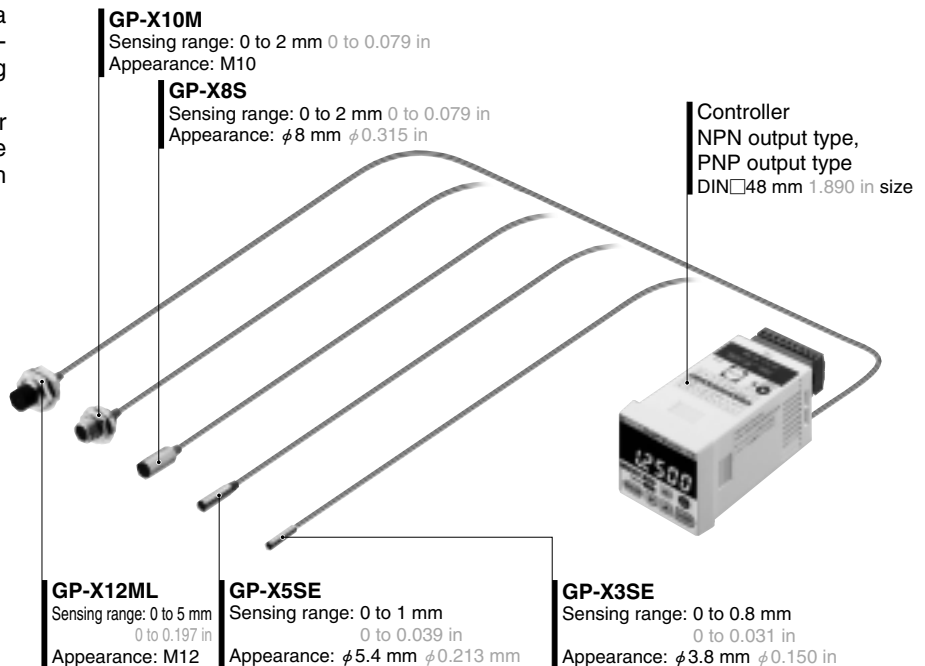

Sensor heads with superior workability and maintainability

Replacement of sensor heads possible

As a result of damage or other mishap rendering maintenance necessary, you can replace only the sensor head leaving the controller as it is.

One-touch connector hook up

The sensor head and the controller connection is a simple one-touch connector type.



One-touch connector

Sensor head extensions possible

Between the sensor head and the controller, a GP-XCCJ7 extension cable (optional) can be used up to a 10 m 32.808 ft total length.

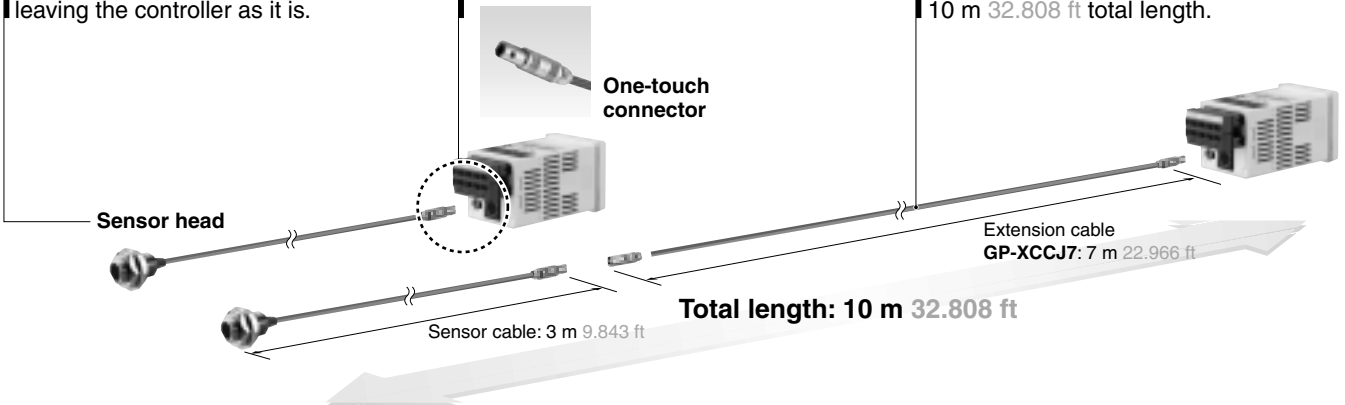

The 5-digit, dual, 2-color digital display offers great visibility

If the measurement results fall within the setting range (GO), they will appear on the lower digital display in green. If they are out of range (HI, LO), they will be displayed in the upper digital display in orange. The display position and color change allows for accurate visibility even for momentary changes.

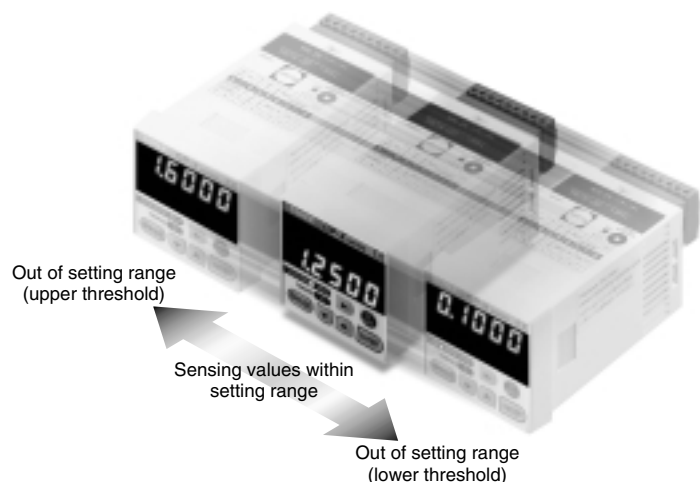

Light / Reflective Type	HL-C1
	LH-50
	LM10
Light / Thru-beam Type	HL-T1
	LA-300
	LA
Magnetic Displacement	GP-X
	GP-A
LD	

GP-X

Digital input display enabling easy setting

Its dual digital display enables numerical setting while verifying setting items for each mode. Even when sensing, it enables the verification of the main settings.

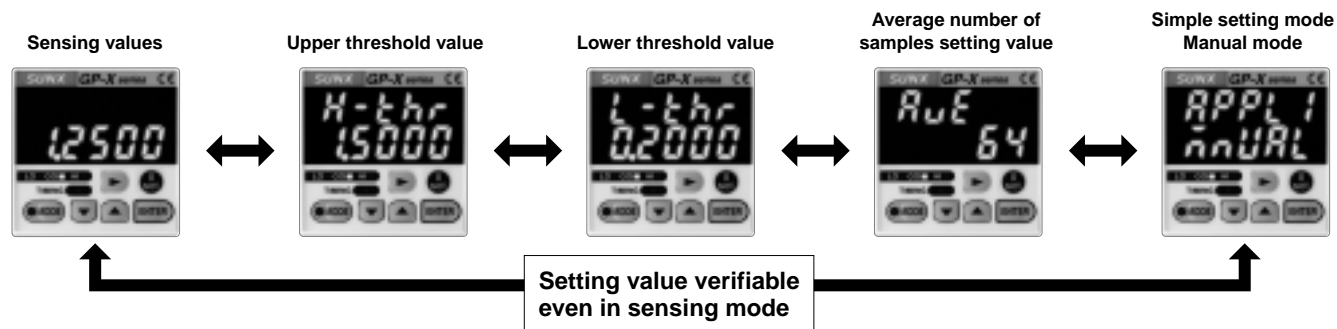

BCD output unit GP-XBCD (Optional)

• 20 kHz high-speed data output

The measurement data can be processed quickly in the PLC.
(Sampling rate: 20 kHz)

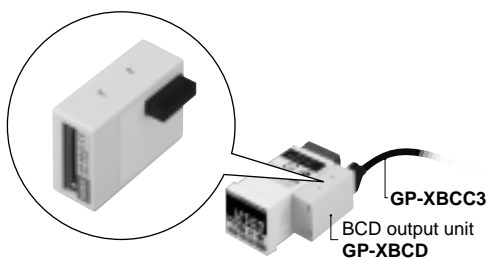

Cable with connector on one end for BCD output unit
GP-XBC33 (Optional)
Cable length: 3 m 9.843 ft
[Controller side: BCD connector]
[Output side: Multi-core cable]

• Mutual interference prevention function

The sensor head can be made interference prevention by linking up to 8 controllers via an interference prevention output cable and shifting the oscillation timing. This enables precise measurements to be obtained even in cases where many sensor heads are crowded in the same area.

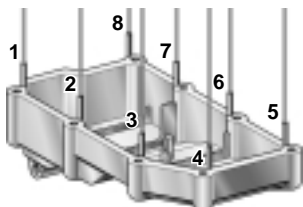

• 4 types of selectable memory functions

The setting data can be processed in 4 types of memory when measuring. This function enables either the changing of the workpiece, the sensing of multiple products or sensing after product changeover to be done smoothly.

• Removable type terminal block

It is equipped with a removable type European terminal block very convenient during assembly, when dividing the equipment into segments or when performing maintenance. It also features an reverse insertion prevention construction.

European terminal block



• 4 types of measurement modes available

Measurement modes compatible to the most widely used applications are available. Because of this, inputting setting values can be done with ease. Please select the most appropriate mode to suit your specific application.

(Stroke end sensing mode)

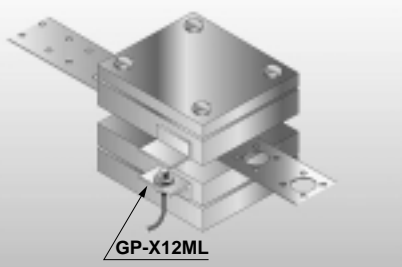
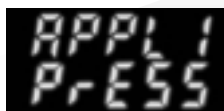

(Rotation / eccentricity / vibration sensing mode)



(Height sensing mode)

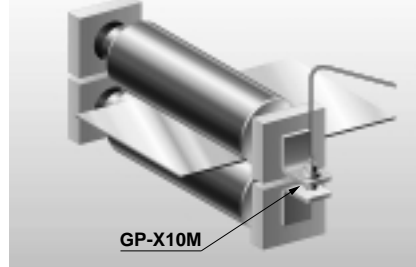

The RS-232C communication connector is standard equipment

It is capable of various controls such as saving measurement data to PC and the controller's inputted settings and loading stored memory.

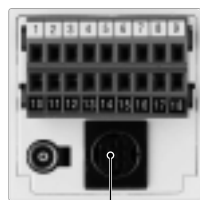

Connector for RS-232C communication

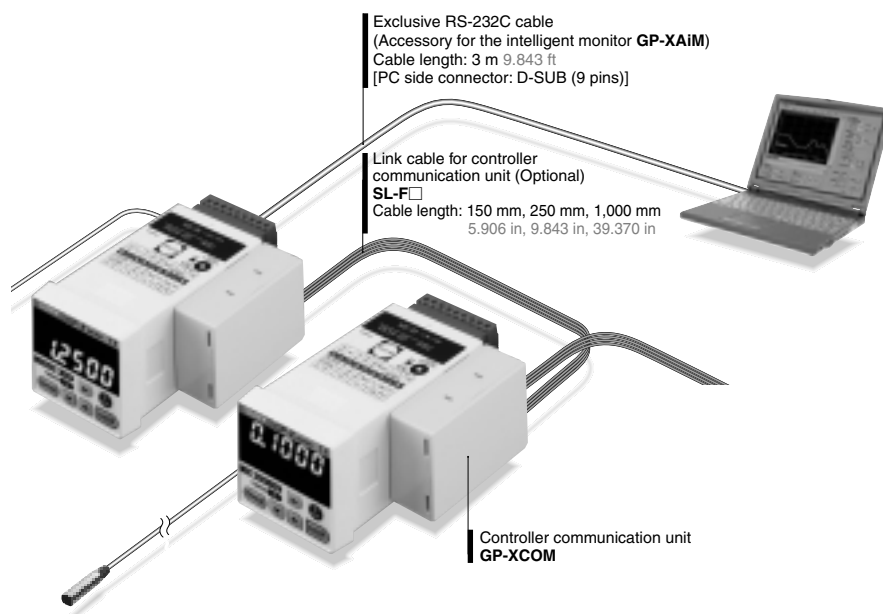

Datalink between sensors possible

The controller communication unit GP-XCOM (optional) can be linked to up to 8 controllers and load via just one RS-232C cable each controller settings and measurement data to a PC.

Maximum of eight units

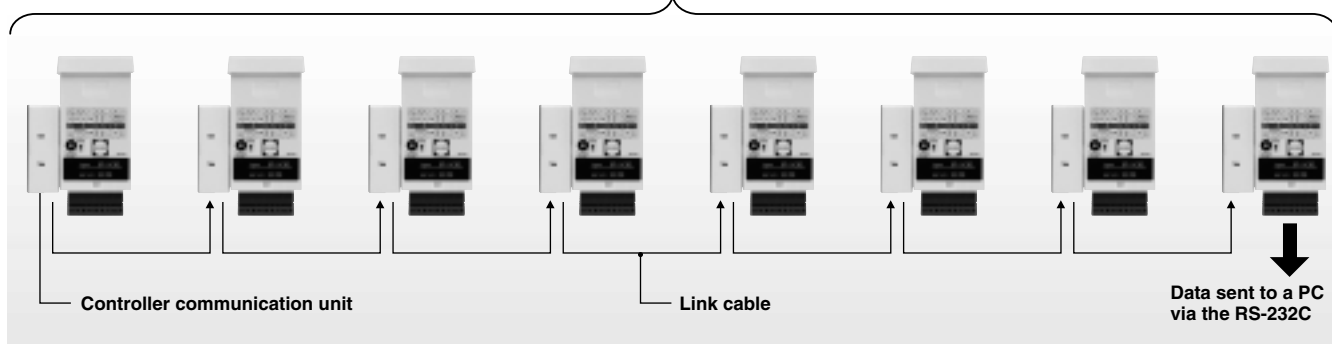

An intelligent monitor (GP-XAiM) optimal for collecting and analyzing measurement data is also available

Coming soon

An intelligent monitor capable of the settings for each measurement conditions and waveform display monitoring. It can perform waveform monitoring, which could until now only be done by the oscilloscope, as well as the simple loading and saving onto a PC of settings for each condition and function. (Exclusive RC-232C cable is attached.)



Enables sensors data comparisons and calculations

3-value judgment output for calculating measurement data conformity and calculation results between 2 inter-connected controllers is rendered possible. The calculation function equipment renders digital panel controllers unnecessary.

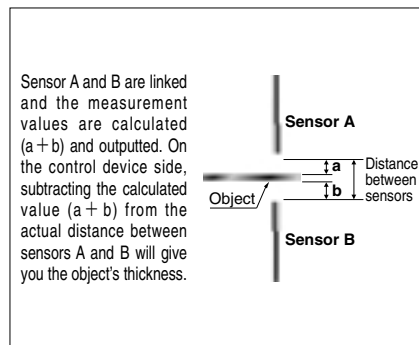

Light / Reflective Type	HL-C1
	LH-50
	LM10
Light / Thru-beam Type	HL-T1
	LA-300
	LA
Magnetic Displacement	LD
	GP-X
	GP-A

GP-X

ORDER GUIDE

Type	Appearance (mm in)		Sensing range	Set model No. (Sensor head model No.)	Comparative output
	Sensor head	Controller			
Non-threaded type sensor head			0 to 0.8 mm 0 to 0.031 in	GP-XC3SE (GP-X3SE) (Note)	NPN open-collector transistor
				GP-XC3SE-P (GP-X3SE) (Note)	PNP open-collector transistor
			0 to 1 mm 0 to 0.039 in	GP-XC5SE (GP-X5SE) (Note)	NPN open-collector transistor
	GP-XC5SE-P (GP-X5SE) (Note)			PNP open-collector transistor	
Threaded type sensor head			0 to 2 mm 0 to 0.079 in	GP-XC8S (GP-X8S)	NPN open-collector transistor
				GP-XC8S-P (GP-X8S)	PNP open-collector transistor
		0 to 2 mm 0 to 0.079 in	GP-XC10M (GP-X10M)	NPN open-collector transistor	
			GP-XC10M-P (GP-X10M)	PNP open-collector transistor	
	0 to 5 mm 0 to 0.197 in	GP-XC12ML (GP-X12ML)	NPN open-collector transistor		
		GP-XC12ML-P (GP-X12ML)	PNP open-collector transistor		

Note: High resolution types (**GP-XC3S**, **GP-XC5S**: 0.02 % F.S., average number of samples: 64) are available. These products correspond to the Export Trade Administration Act of Japan. Shipping them outside Japan requires special permission from the Japanese government regarding stipulations in Foreign Exchange and Foreign Trade Law. Please contact our office for details.

OPTIONS

Designation	Model No.	Description
BCD output unit	GP-XBCD	This unit outputs measurement values in BCD data format at a high speed. • Sampling frequency : 20 kHz
Cable with connector on one end for BCD output unit	GP-XBCC3	Length: 3 m 9.843 ft Cable for BCD data output unit • 26-core cable with connector on one end
Controller communication unit	GP-XCOM	Up to 8 controllers can be linked
Link cable for controller communication unit	SL-F150	Length: 150 mm 5.906 in
	SL-F250	Length: 250 mm 9.843 in
	SL-F1000	Length: 1,000 mm 39.370 in
Intelligent monitor	GP-XAiM	Monitoring settings for each measurement condition and measurement waveforms is enabled by way of a PC. • Attached one exclusive RS-232C cable (3 m 9.843 ft length)
Extension cable for sensor head	GP-XCCJ7	Length: 7 m 22.966 ft This cable with connectors is for extensions between the sensor head and controller.

BCD output unit
Cable with connector on one end for BCD output unit
• **GP-XBCD**
• **GP-XBCC3**

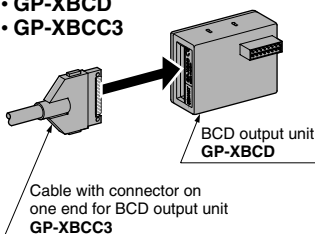

Controller communication unit
Link cable for controller communication unit
• **GP-XCOM**
• **SL-F□**

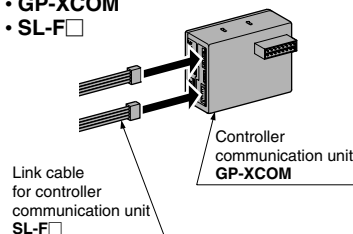

Intelligent monitor
• **GP-XAiM**



Extension cable for sensor head
• **GP-XCCJ7**

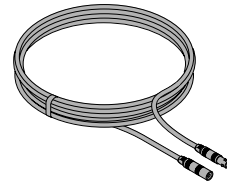

SPECIFICATIONS

Sensor heads

Type		Non-threaded type			Threaded type	
		For 0.8 mm 0.031 in sensing	For 1 mm 0.039 in sensing	For 2 mm 0.079 in sensing	For 2 mm 0.079 in sensing	For 5 mm 0.197 in sensing
Item	Model No.	GP-X3SE	GP-X5SE	GP-X8S	GP-X10M	GP-X12ML
Sensing range (Note 1)		0 to 0.8 mm 0 to 0.031 in	0 to 1 mm 0 to 0.039 in	0 to 2 mm 0 to 0.079 in	0 to 2 mm 0 to 0.079 in	0 to 5 mm 0 to 0.197 in
Standard sensing object		Stainless steel (SUS304) / Iron sheet 60 × 60 × t 1 mm 2.362 × 2.362 × t 0.039 in				
Temperature characteristics (Note 2)		0.07 % F.S./°C or less				
Environmental resistance	Pollution degree	3 (Industrial environment)				
	Protection	IP67 (IEC), IP67g (JEM)				
	Ambient temperature	− 10 to + 55 °C + 14 to + 131 °F, Storage: − 20 to + 70 °C − 4 to + 158 °F				
	Ambient humidity	35 to 85 % RH, Storage: 35 to 85 % RH				
	Voltage withstandability	250 V AC for one min. between all supply terminals connected together and enclosure				
	Insulation resistance	20 MΩ, or more, with 250 V DC megger between all supply terminals connected together and enclosure				
	Vibration resistance	10 to 150 Hz frequency, 0.75 mm 0.030 in amplitude in X, Y and Z directions for two hours each				
	Shock resistance	500 m/s ² acceleration (50 G approx.) in X, Y and Z directions for five times each				
Material	Enclosure	Stainless steel (SUS303)				Brass (Nickel plated)
	Cable protector	PP				
	Sensing parts	ABS	PAR	ABS	PA	
Cable		Connector attached high frequency coaxial cable, 3 m 9.843 ft long (Note 3)				
Cable extension		Extension up to total 10 m 32.808 ft is possible with the optional cable				
Weight (Note 4)		40 g approx.	40 g approx.	40 g approx.	50 g approx.	45 g approx.
Accessories					Nut: 2 pcs., Toothed lock washer: 1 pc.	

Notes: 1) The sensing range is specified for the standard sensing object.

2) This value represents 20 to 60 % of the maximum sensing distance when combining the sensor head and controller.

3) For the flexible cable type, please contact our office.

4) The given weight of the threaded type sensor head is the value including the weight of the nuts and the toothed lock washer.

SPECIFICATIONS

Controllers

Type	NPN output	PNP output	
Item	Set model No.	GP-XC□-P	
Supply voltage	24 V DC \pm 10 % Ripple P-P 10 % or less		
Current consumption	150 mA or less		
Resolution (Note 1)	GP-XC3SE / GP-XC5SE: 0.04 % F.S. (64 times average processing) GP-XC8S / GP-XC10M / GP-XC12ML: 0.02 % F.S. (64 times average processing)		
Sampling frequency	40 kHz (25 μ s)		
Linearity (Note 1)	Within \pm 0.3 % F.S.		
Temperature characteristics (Note 2)	0.07 % F.S./°C or less		
Analog voltage output	Output voltage: - 5 to + 5 V (Note 3), Output impedance: 100 Ω approx.		
Response time	75 μ s (maximum speed)		
Comparative output (HI, GO, LO)	NPN open-collector transistor • Maximum sink current: 100 mA • Applied voltage: 30 V DC or less (between comparative output and 0 V) • Residual voltage: 1.6 V or less (at 100 mA sink current) 0.4 V or less (at 16 mA sink current)	PNP open-collector transistor • Maximum source current: 100 mA • Applied voltage: 30 V DC or less (between comparative output and + V) • Residual voltage: 1.6 V or less (at 100 mA source current) 0.4 V or less (at 16 mA source current)	
Utilization category	DC-12 or DC-13		
Output number	HI / GO / LO 3 value output		
Output operation	HI : ON when measured value > the upper limit value GO : ON when upper limit value \geq measured value \geq lower limit value LO : ON when lower limit value > measured value		
Short-circuit protection	Incorporated		
External input	Photocoupler input • Input current: 9 mA or less • Operating voltage: ON voltage 17 V or more (between + 24 V and input) OFF voltage 4 V or less (between + 24 V and input) • Input impedance: 5 k Ω approx.	Photocoupler input • Input current: 9 mA or less • Operating voltage: ON voltage 17 V or more (between 0 V and input) OFF voltage 4 V or less (between 0 V and input) • Input impedance: 5 k Ω approx.	
Serial I/O	RS-232C		
Zero-set setting method	Push button setting / External input setting		
Indicator	MODE	Orange LED (lights up when in mode status)	
	HI	Orange LED (lights up when the upper limit value is exceeded)	
	GO	Green LED (lights up when within the upper and lower limit value)	
	LO	Orange LED (lights up when less than the lower limit value)	
	TIMING	Green LED (lights up as per the external or internal trigger timing)	
Upper level digital display part	5 digit orange LED (display of numerical values out of upper and lower limit value)		
Lower level digital display part	5 digit green LED (display of numerical values within the upper and lower limit value)		
Environmental resistance	Pollution degree	3 (Industrial environment)	
	Ambient temperature	0 to + 50 °C + 32 to + 122 °F (No dew condensation), Storage: 0 to + 50 °C + 32 to + 122 °F	
	Ambient humidity	35 to 85 % RH, Storage: 35 to 85 % RH	
	EMC	EN 61000-6-2, EN 61000-6-4	
	Vibration resistance	10 to 55 Hz frequency, 0.75 mm 0.030 in amplitude in X, Y and Z directions for two hours each	
	Shock resistance	100 m/s ² acceleration (10 G approx.) in X, Y and Z directions for five times each	
Material	Enclosure: Polycarbonate		
Weight	120 g approx.		
Accessory	ATA4811 (Controller mounting frame): 1 set		

Notes: 1) This value was obtained at a constant + 25 °C + 77 °F.

2) This value represents 20 to 60 % of the maximum sensing distance when combining the sensor head and controller.

3) Adjusted to a 0 to + 5 V factory setting.

BCD output unit

Model No.	GP-XBCD
Current consumption	20 mA or less
Output (5 digits BCD, Polarity indication, VALID)	N-channel MOSFET open drain • Maximum sink current: 50 mA • Applied voltage: 30 V DC or less (between output and GND) • Residual voltage: 1 V or less (at 50 mA sink current)
Hold input	Non-voltage contact or NPN open-collector transistor input • Low: 0 to 1 V • High: Open
Material	Enclosure: ABS
Weight	30 g approx.
Accessory	Mounting bracket [Stainless steel (SUS304)]: 1 pc.

Note: Connects to the control device with GP-XBCC3 cable with connector on one end for BCD output unit (3 m 9.843 ft cable length, optional).

Controller communication unit

Model No.	GP-XCOM
Current consumption	5 mA or less
Material	Enclosure: ABS
Weight	20 g approx.
Accessory	Mounting bracket [Stainless steel (SUS304)]: 1 pc.

Note: Each GP-XCOM is connected using a link cable for controller communication units (SL-F□, optional).

I/O CIRCUIT AND WIRING DIAGRAMS

NPN output type controller

I/O circuit diagram

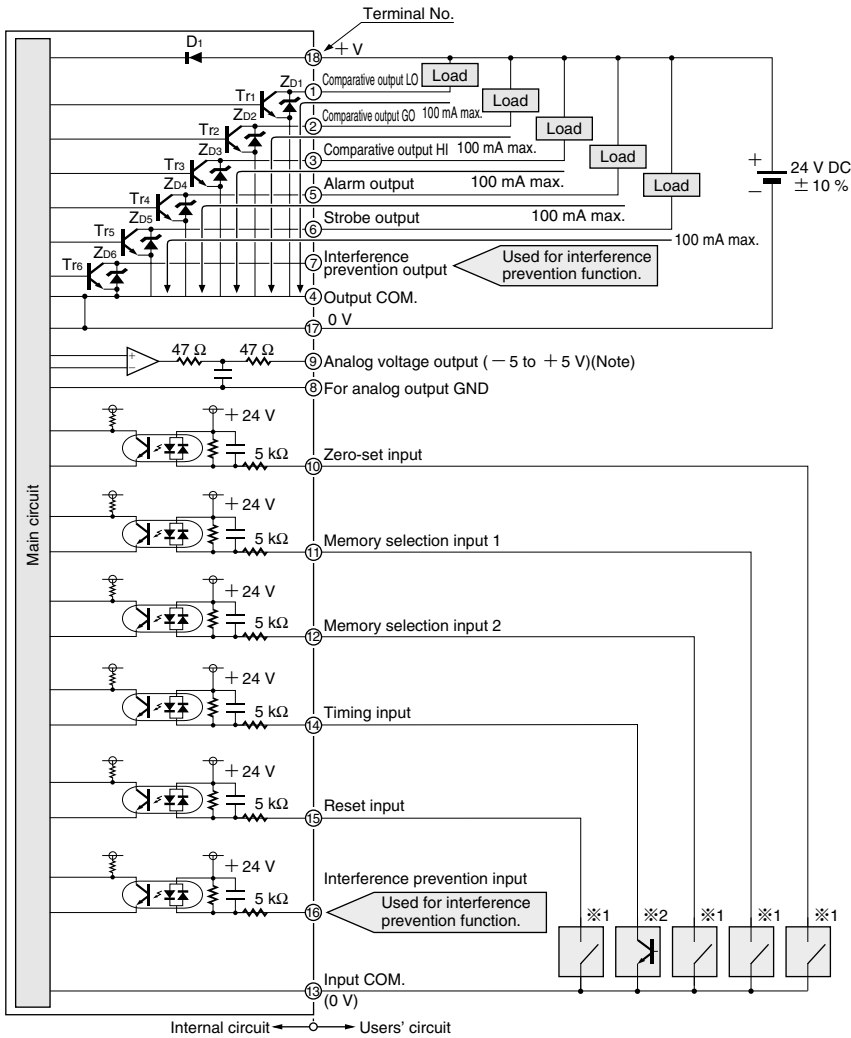

Note: Devices connected to the analog voltage output must have an input impedance set at 1 MΩ or more.

Symbols ... D1: Reverse supply polarity protection diode
 ZD1 to ZD6: Surge absorption zener diode
 Tr1 to Tr8: NPN output transistor

※1

Non-voltage contact or NPN open-collector transistor

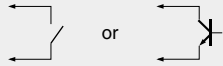

• Zero-set input, reset input, memory selection input
 Low (0 to 4 V): Effective
 High (+ V or open): Ineffective

※2

NPN open-collector transistor



• Timing input
 Low (0 to 4 V): Effective
 High (+ V or open): Ineffective

Memory selection input

Memory No.	Memory selection 1	Memory selection 2
0	High	High
1	Low	High
2	High	Low
3	Low	Low

Light / Reflective Type

HL-C1

LH-50

LM10

Light / Thru-beam Type

HL-T1

LA-300

LA

LD

Magnetic Displacement

GP-X

GP-A

I/O CIRCUIT AND WIRING DIAGRAMS

PNP output type controller

I/O circuit diagram

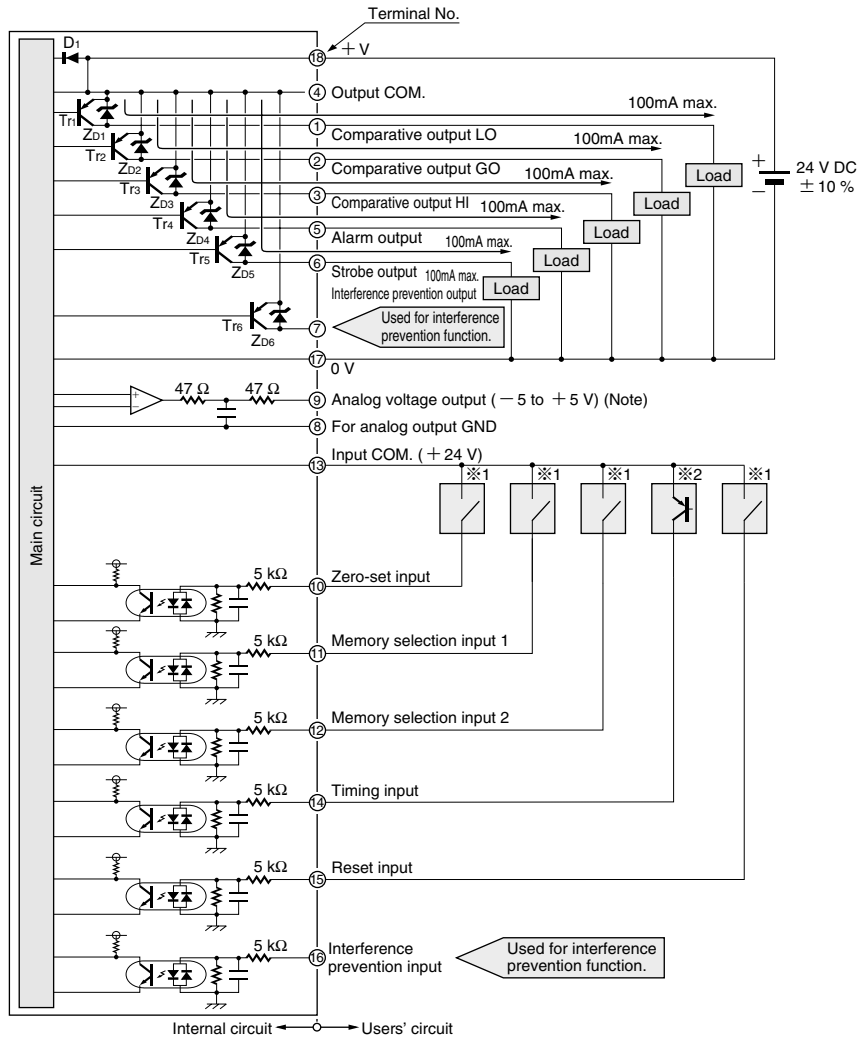

Note: Devices connected to the analog voltage output must have an input impedance set at 1 MΩ or more.

Symbols ... D1: Reverse supply polarity protection diode
 ZD1 to ZD6: Surge absorption zener diode
 Tr1 to Tr6: PNP output transistor

※1
 Non-voltage contact or PNP open-collector transistor

• Zero-set input, reset input, memory selection input
 Low (0 V or open): Ineffective
 High (+17 to +24 V): Effective

※2
 PNP open-collector transistor

• Timing input
 Low (0 V or open): Ineffective
 High (+17 to +24 V): Effective

Memory selection input

Memory No.	Memory selection 1	Memory selection 2
0	Low	Low
1	High	Low
2	Low	High
3	High	High

I/O CIRCUIT AND WIRING DIAGRAMS

Controller

Terminal arrangement

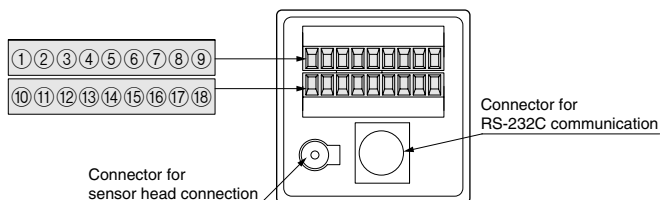

Terminal No.	Description
①	Comparative output LO
②	Comparative output GO
③	Comparative output HI
④	Output COM.
⑤	Alarm output
⑥	Strobe output
⑦	Interference prevention output
⑧	For analog output GND
⑨	Analog output

Terminal No.	Description
⑩	Zero-set input
⑪	Memory selection input 1
⑫	Memory selection input 2
⑬	Input COM.
⑭	Timing input
⑮	Reset input
⑯	Interference prevention input
⑰	0 V
⑱	+V

BCD output unit

Connector pin position and cable color

Connector pin No.	Cable		Signal	Description	
	Sheath color	ID mark			
①	Orange	Red: 1	A0	1 ×	Measurement value to the 10 ⁰ digit
②	Orange	Black: 1	B0	2 ×	
③	Gray	Red: 1	C0	4 ×	
④	Gray	Black: 1	D0	8 ×	
⑤	White	Red: 1	A1	1 ×	Measurement value to the 10 ¹ digit
⑥	White	Black: 1	B1	2 ×	
⑦	Yellow	Red: 1	C1	4 ×	
⑧	Yellow	Black: 1	D1	8 ×	
⑨	Pink	Red: 1	A2	1 ×	Measurement value to the 10 ² digit
⑩	Pink	Black: 1	B2	2 ×	
⑪	Orange	Red: 2	C2	4 ×	
⑫	Orange	Black: 2	D2	8 ×	
⑬	Gray	Red: 2	A3	1 ×	Measurement value to the 10 ³ digit
⑭	Gray	Black: 2	B3	2 ×	
⑮	White	Red: 2	C3	4 ×	
⑯	White	Black: 2	D3	8 ×	
⑰	Yellow	Red: 2	A4	1 ×	Measurement value to the 10 ⁴ digit
⑱	Yellow	Black: 2	B4	2 ×	
⑲	Pink	Red: 2	C4	4 ×	
⑳	Pink	Black: 2	D4	8 ×	
㉑	Orange	Red: 3	POLE	Polarity signal output	High (OFF): +, Low (ON): -
㉒	Orange	Black: 3	VALID	VALID output	Low (ON) when the data output is enabled
㉓	Gray	Red: 3	HOLD	Hold input	This input is to maintain the external data output. The data output is maintained during low (ON).
㉔	Gray	Black: 3	GND	Ground	—
㉕	White	Red: 3	GND	Ground	—
—	White	Black: 3	—	Not connected	Not used

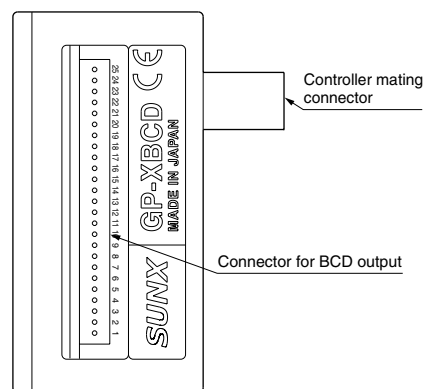

Note: The shield wire is connected externally at 0 V.

Light / Reflective Type

HL-C1
LH-50

LM10
HL-T1

Light / Thru-beam Type

LA-300

LA

LD

Magnetic Displacement

GP-X

GP-A

GP-X

PRECAUTIONS FOR PROPER USE



This product is not a safety sensor. Its use is not intended or designed to protect life and prevent body injury or property damage from dangerous parts of machinery. It is a normal object detection sensor.

- The sensor head and controller are adjusted in order to conform to the default specification linearity.
- In the event of replacing sensor heads, input the sensor head's characteristic code and conduct 3-point correction (calibration).
- Should you use an extension cable, turn the sensor head cable length selection switch located on the back of the controller to '3 m + 7 m 9.843 ft + 22.966 ft'. Then reintroduce the power supply and conduct 3-point correction (calibration).

Conditions in use for CE conformity

- This sensor is a CE conformity product complying with EMC Directive. The harmonized standard with regard to immunity that applies to this product is EN 61000-6-2 and the following conditions must be met to conform to that standard.

Conditions

- The controller should be connected less than 10 m 32.808 ft from the power supply.
- The signal line to connect with the controller should be less than 30 m 98.425 ft.
- A ferrite clamp must be mounted within 10 mm 0.394 in from connector fitted onto the **GP-XBCC3** cable with connector on one end for BCD output units.

The EN 50082-2 that previously applied to the products for conforming to EMC Directive was replaced by EN 61000-6-2 starting April 1st, 2002.

Linearity in case of disc-shaped or cylindrical objects

- In case the sensing object is disc-shaped or cylindrical, the linearity varies with the sensing object size. In the event the sensing object is larger than the sizes indicated in the table below, the linearity specification (within $\pm 0.3\%$ F.S) is satisfied by performing zero-adjustment and span adjustment when in contact using the scaling function.

Sensor head	Disc diameter ϕ (mm in)	Cylinder diameter ϕ (mm in)
GP-X3SE	6 0.236	16 0.630
GP-X5SE	8 0.315	16 0.630
GP-X8S	12 0.472	50 1.969
GP-X10M	12 0.472	50 1.969
GP-X12ML	25 0.984	55 2.165

<In case of disc>

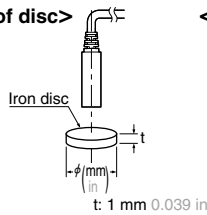

<In case of cylinder>

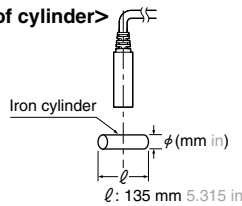

Mounting sensor head

- The tightening torque should be under the value given below.

Mounting with set screw

- Make sure to use an M3 or smaller set screw having a cup-point.

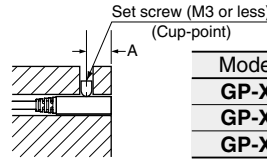

Model No.	A (mm in)	Tightening torque
GP-X3SE	4 to 16 0.157 to 0.630	0.10 N·m or less
GP-X5SE	5 to 16 0.197 to 0.630	0.44 N·m or less
GP-X8S		0.58 N·m or less

Mounting with nut

<GP-X10M>

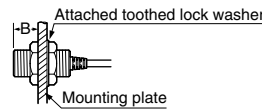

<GP-X12ML>

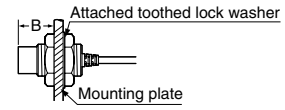

Model No.	B (mm in)	Tightening torque
GP-X10M	7 0.276 or more	9.8 N·m or less
GP-X12ML	14 0.551 or more	20 N·m or less

Distance from surrounding metal

- As metal around the sensor head may affect the sensing performance, pay attention to the following points.

<Embedding of the sensor head in metal>

- Since the analog output may change if the sensor head is completely embedded in metal, keep the minimum distance specified in the table below.

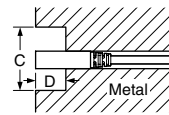

Sensor head	C (mm in)	D (mm in)
GP-X3SE	$\phi 10 \phi 0.394$	3 0.118
GP-X5SE		
GP-X8S	$\phi 18 \phi 0.709$	
GP-X10M	$\phi 14 \phi 0.551$	
GP-X12ML	$\phi 50 \phi 1.969$	14 0.551

Mutual interference

- If several sensor heads are mounted close together, some specifications may not be satisfied. Therefore, proceed with the interference prevention function enabled. The interference prevention function eliminates interference among sensors by alternating sensor oscillations. Contact our office for details about time charts etc. If not using the interference prevention function, leave a distance more than the values given below.

<Face to face mounting>

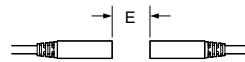

Sensor head	E (mm in)	F (mm in)
GP-X3SE	15 0.591	9 0.354
GP-X5SE	30 1.181	11 0.433
GP-X8S	40 1.575	15 0.591
GP-X10M	40 1.575	15 0.591
GP-X12ML	170 6.693	50 1.969

<Parallel mounting>

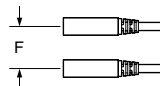

PRECAUTIONS FOR PROPER USE

Sensing range

- The specified sensing range is specified for the standard sensing object [stainless steel (SUS304) / iron, 60 × 60 × t 1 mm 2.362 × 2.362 × t 0.039 in]. For sensing metals other than the standard sensing objects, use the correction coefficient stated below as a guideline. Verify with the actual sensor before using.

Correction coefficient

Sensor head	GP-X3SE	GP-X10M
Metal	GP-X5SE	GP-X12ML
GP-X8S		
Stainless steel (SUS304), Iron	1	
Aluminum	0.5 approx.	

Connection of sensor head and controller

- Make sure that the power supply is off while connecting the sensor head to the controller.

Connection

- Hold the sensor head's connector by the outer ring and insert it into the connector provided on the controller for sensor head connection. Insert till you hear a click sound.

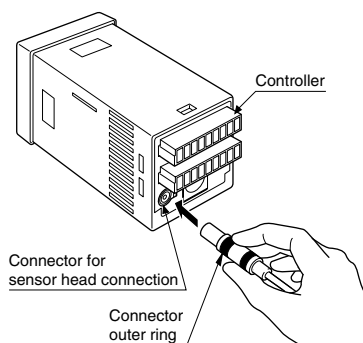

Removing

- When removing, hold the connector by the outer ring and pull it straight out.

Cable extension for sensor head

- When using a sensor head extension cable, turn the sensor head cable length selection switch side to the controller's sensor head connector to '3 m + 7 m 9.843 ft + 22.966 ft' with the power supply is off. After switching, reintroduce the power supply.

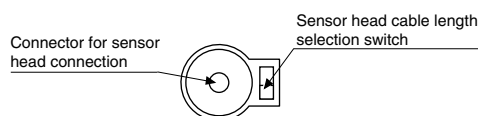

UP side: Standard (3 m 9.843 ft) + Extension (7 m 22.966 ft)
DOWN side: Standard (3 m 9.843 ft)(factory shipment setting)

Mounting controller

- Use the attached controller mounting frame (ATA4811) and mount the controller onto the panel by fastening the frame's screws.

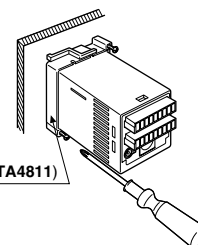

Controller mounting frame (ATA4811)

- Refer to the 'DIMENSIONS' (p.984) for the panel cut dimension.
- The mountable panel thickness is 1 to 5 mm 0.039 to 0.197 in. However, if using a controller communication unit or BCD output unit, make the panel thickness between 1 to 2.5 mm 0.039 to 0.098 in.

Wiring

- Make sure that the power supply is off while wiring.
- Take care that wrong wiring will damage the sensor head or the controller.
- Verify that the supply voltage variation is within the rating.
- If power is supplied from a commercial switching regulator, ensure that the frame ground (F.G.) terminal of the power supply is connected to an actual ground.
- In case noise generating equipment (switching regulator, inverter motor, etc.) is used in the vicinity of the sensor head or the controller, connect the frame ground (F.G.) terminal of the equipment to an actual ground.
- Do not run the wires together with high-voltage lines or power lines or put them in the same raceway. This can cause malfunction due to induction.
- Make sure to use an isolation transformer for the power supply. If an auto-transformer (single winding transformer) is used, this product or the power supply may get damaged.
- In case a surge is generated in the used power supply, connect a surge absorber to the supply and absorb the surge.
- The analog voltage output does not incorporate a short-circuit protection circuit. Do not directly connect a power supply or a capacitive load.
- Make sure that stress by forcible bend or pulling is not applied directly to the sensor cable joint.

Others

- Do not use during the initial transient time (2 sec. approx.) after the power supply is switched on.
- This sensor is suitable for indoor use only.
- Avoid dust, dirt, and steam.
- Take care that the product does not come in direct contact with water, oil, grease, or organic solvents, such as, thinner, etc.

DIMENSIONS (Unit: mm in) The CAD data in the dimensions can be downloaded from the SUNX website: <http://www.sunx.co.jp/>

GP-X3SE Sensor head

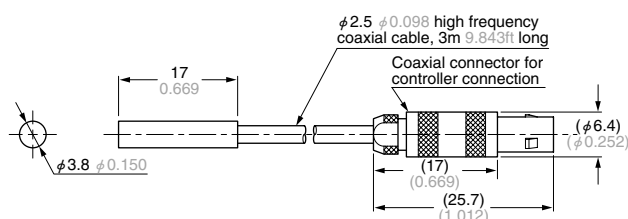

GP-X5SE Sensor head

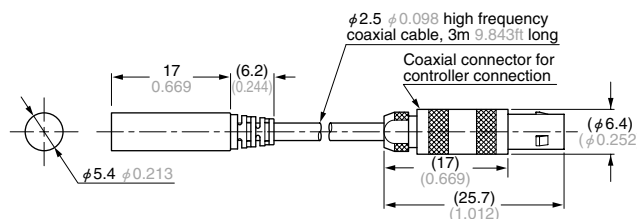

GP-X

DIMENSIONS (Unit: mm in) The CAD data in the dimensions can be downloaded from the SUNX website: <http://www.sunx.co.jp/>

GP-X8S Sensor head

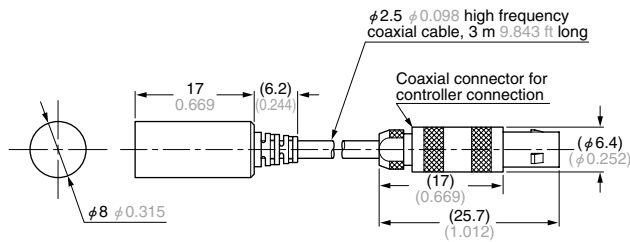

GP-X10M Sensor head

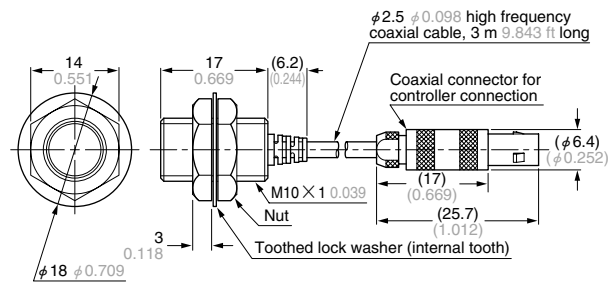

GP-X12ML Sensor head

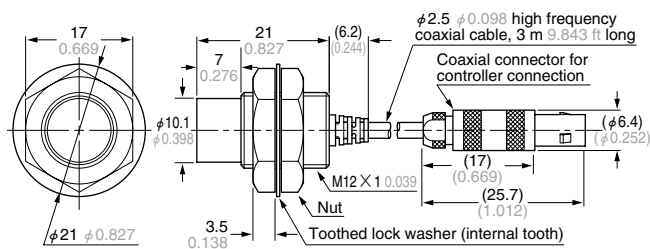

Controller

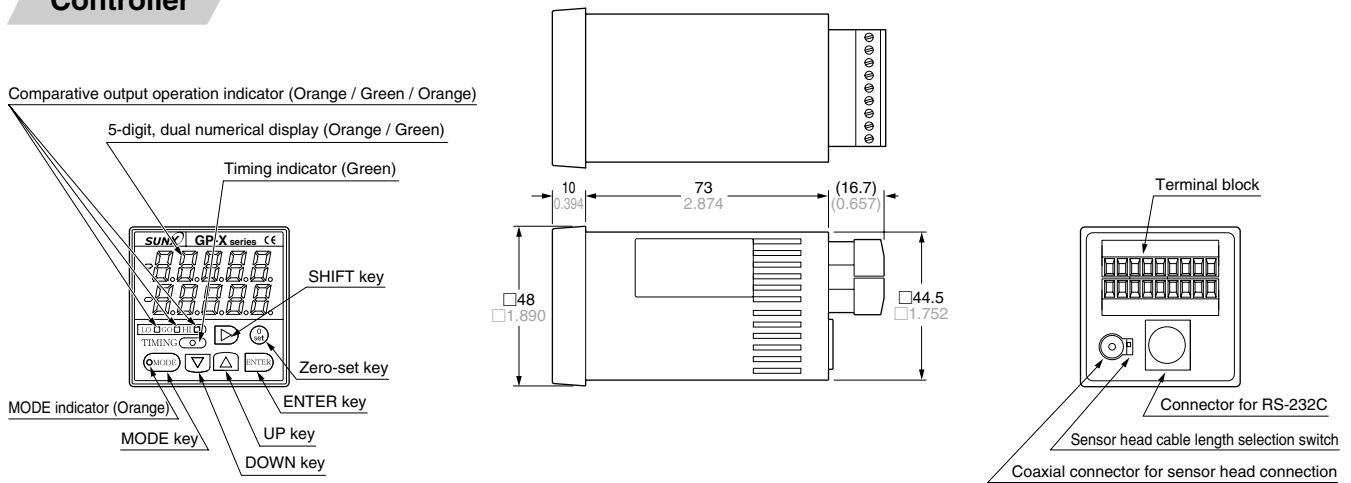

Panel cut-out dimensions

<When BCD output unit / controller communication unit not mounted>

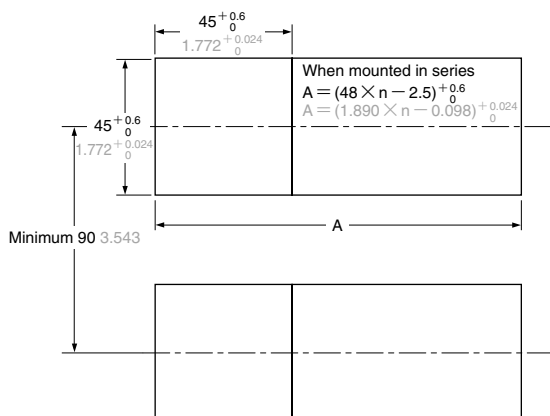

Note: The panel thickness should be 1 to 5 mm 0.039 to 0.197 in.

<When BCD output unit / controller communication unit mounted>

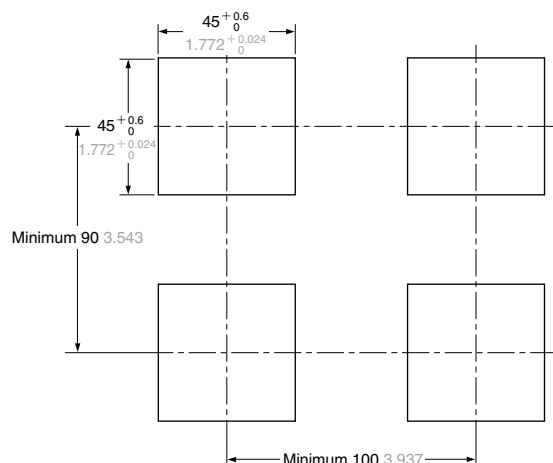

Note: The panel thickness should be 1 to 2.5 mm 0.039 to 0.098 in.

